

PST-214P

Option A
Pendant

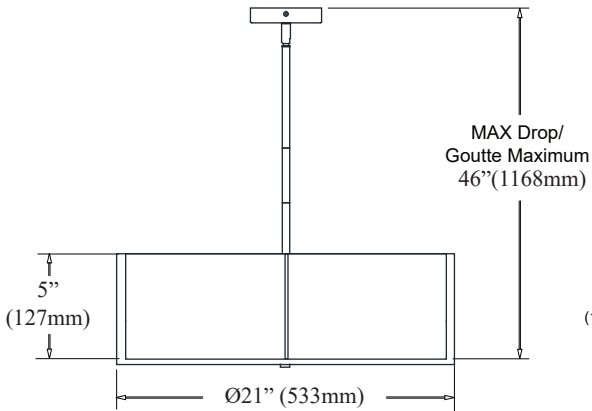

Option B
Semi-Flush

