

# ARY-3260LEDC

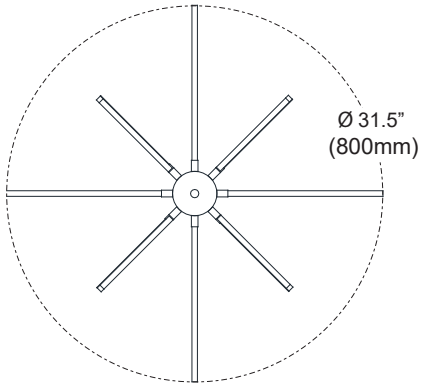

Top View

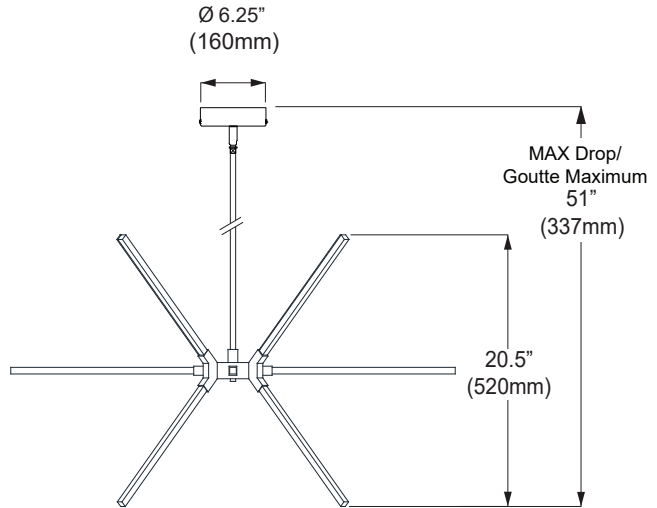

Side View